

*ALL COLOURS

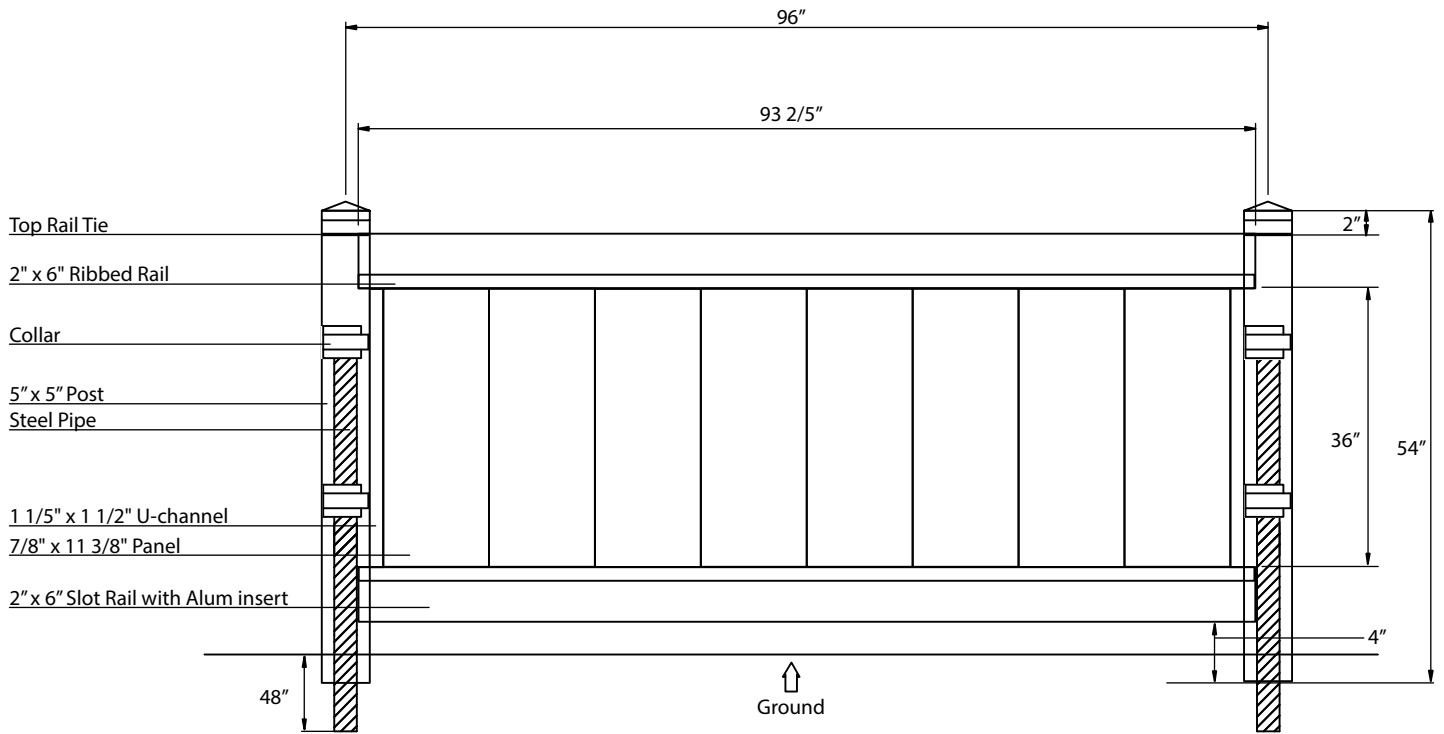

Material per section

Item	Dimension	Thickness	Qty
Post	5" x 5" x 54"	0.150"	1
Top Rail	2" x 6" x 93 2/5"	0.080"	1
Bottom Rail	2" x 6" x 93 2/5"	0.080"	1
U-Channel	1 3/8" x 36"	0.080"	2
Panel	7/8" x 11 3/8" x 38 3/4"	0.051"	8
Steel Pipe	2 3/8" x 96"		1
Top Rail Tie	5" x 5"		1
Collar	5" x 5"		2
Alum	93 2/5"		1
Post Cap	Flat Cap		1

Side view of Alum insert

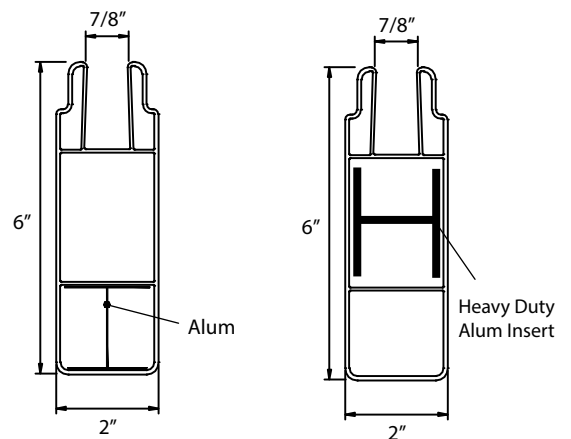

* WHITE

- * TAN
- * GRAY
- * ADOBE
- * GREY OAK
- * SILVER BIRCH